

20 000 985

- hole diameter valve 32 mm
- rosette 60 x 60 mm
- with hot marking



20 000 985

mm [inches]

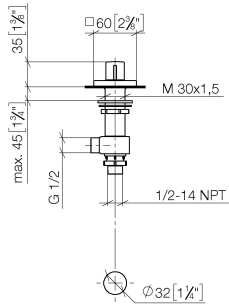

Flow rate chart

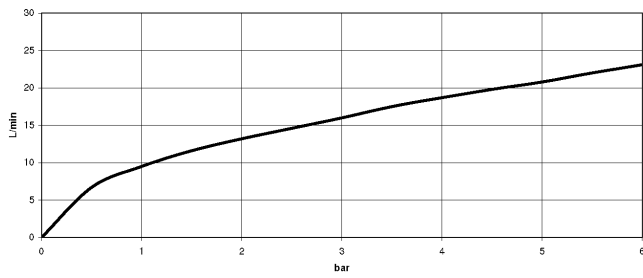

Certificates

IAPMO_4976 (5). ETA_18519. IAPMO_6397.

20 000 985

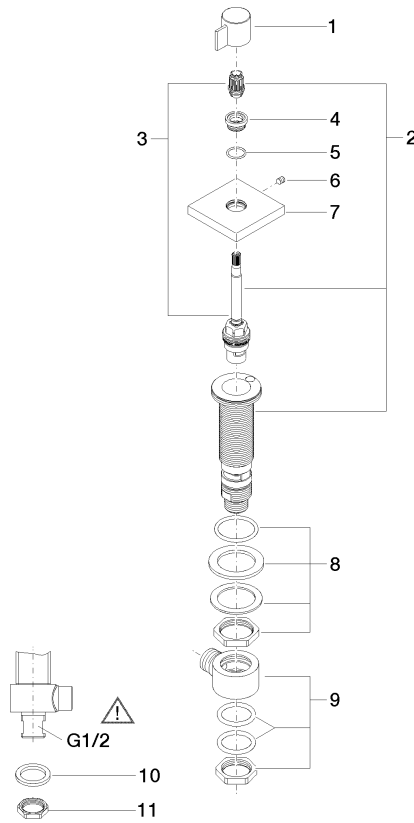

Spare parts list

No.	Item Number	Name	Quantity used	Delivery time
1	09 20 98 002-00	handle	1	10
2	90 17 11 045 04 90	side panel	1	2
3	90 90 03 204 00 90	top	1	2
4	09 12 12 043-00	base	1	10
5	09 14 10 017 90	seal	1	2
6	90 31 11 004 00 90	pin	1	2
7	09 27 98 014-00	rosette	1	10
8	04 23 10 032 78 90	fixing set	1	2
9	04 17 11 023 10 90	distributor	1	2
10	09 30 11 059 90	disc	1	2
11	09 23 10 012 90	nut	1	2